

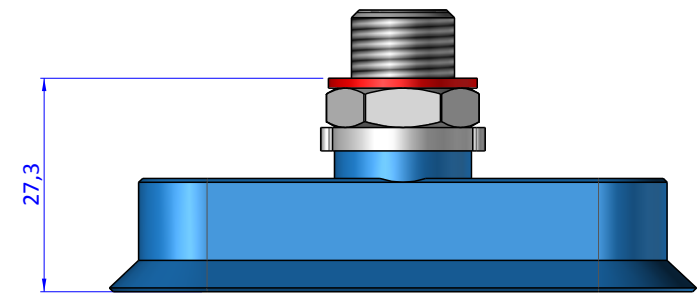

Item	Name	Q.ty
1	10.07.10.00033.D17	1
2	CA.08.09.14	1
3	CA.08.09.041	1
4	CA.08.39.008	1

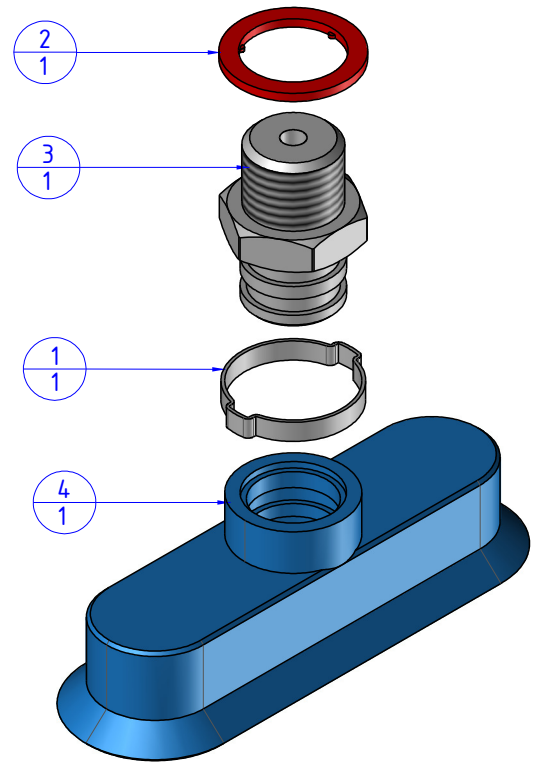
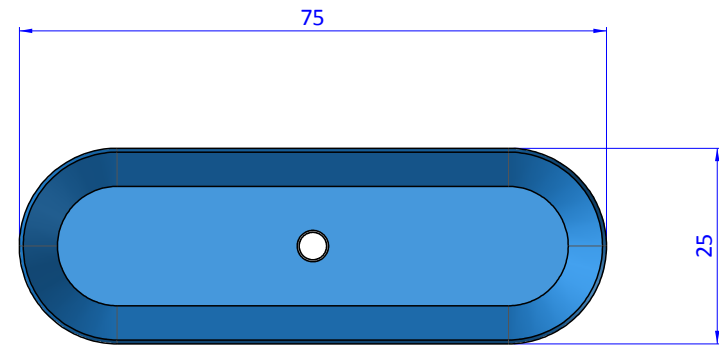

THE PROPERTY OF THE DRAWING IS ESTABLISHED BY LAW. IT IS FORBIDDEN TO PRODUCE OR SHOW IT TO THIRD PARTY, WITHOUT A WRITTEN AGREEMENT.

Format A3  
UNI 936-76

 <b>FPS</b> FPSERVICES AUTOMATION		DESIGNED FROM		REVIEW
		FPS Automation		A
GENERAL TOLERANCE		DATE	WEIGHT	
UNI - ISO 2768		21/03/2019	0,010kg	
CLASSE f	DESCRIPTION	CODE		
	KIT.08.39.L75.41	KIT.08.39.L75.41		